

ELEMENTS

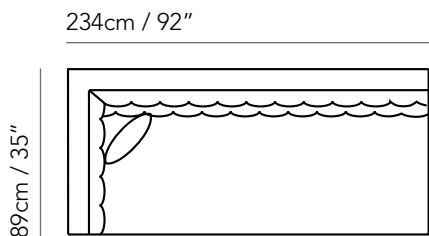

1061-92

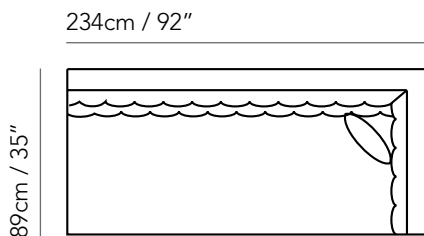

1062-92

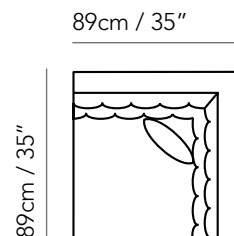

1065-35

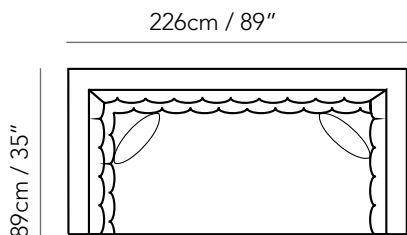

1064-89

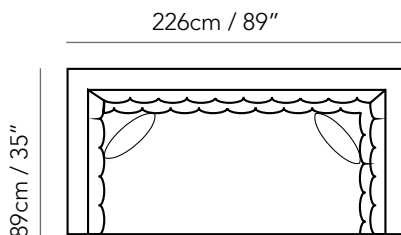

1063-89

COMBINATIONS

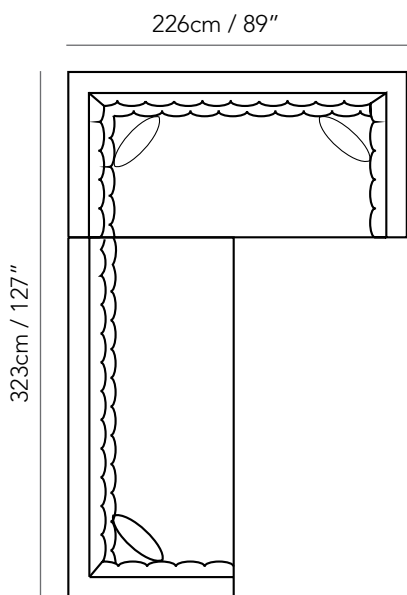

1061-92+1064-89

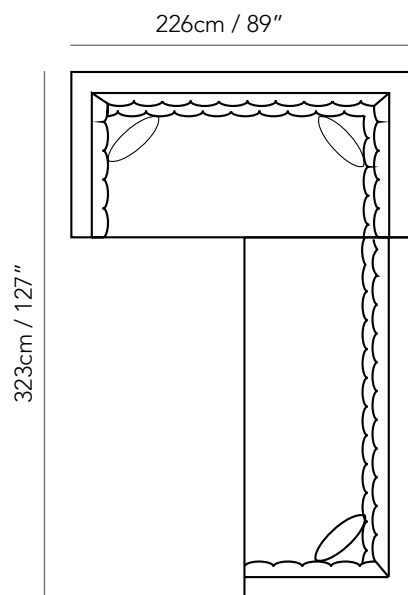

1063-89+1062-92

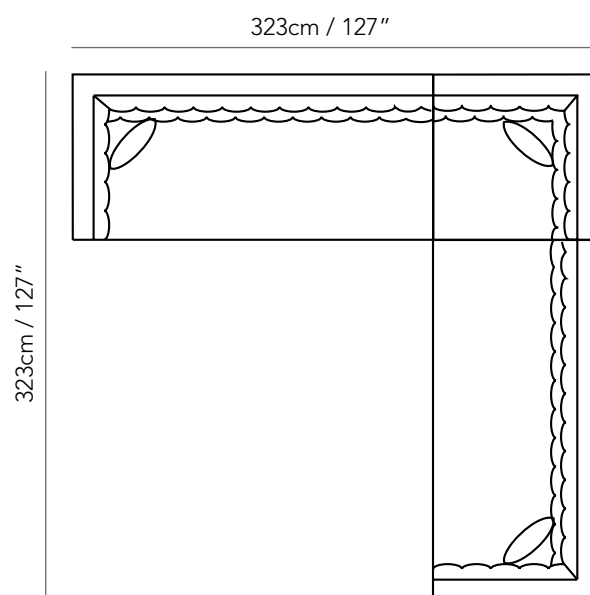

1061-92+1065-35+1062-92